

MEIN **NEON** BASTELBUCH

Alle Rechte dieser Ausgabe bei © Edition Michael Fischer GmbH, Igling
www.emf-verlag.de
ISBN 978-3-7459-2335-3

AST, S. 16



MEIN **NEON** BASTELBUCH

Alle Rechte dieser Ausgabe bei © Edition Michael Fischer GmbH, Igling
www.emf-verlag.de
ISBN 978-3-7459-2335-3

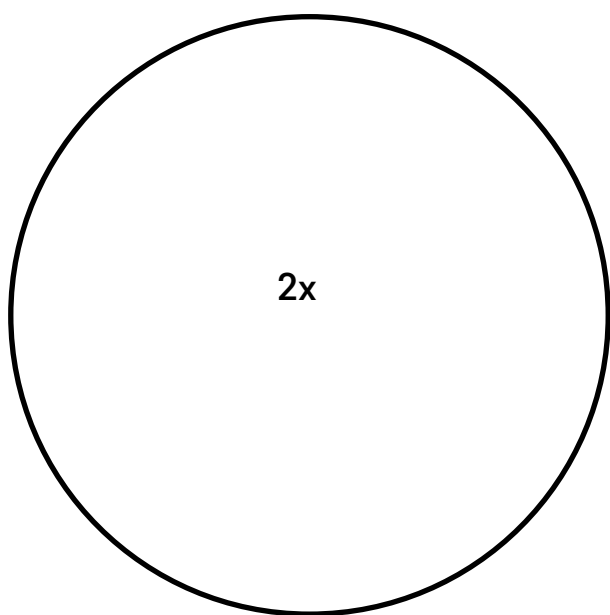
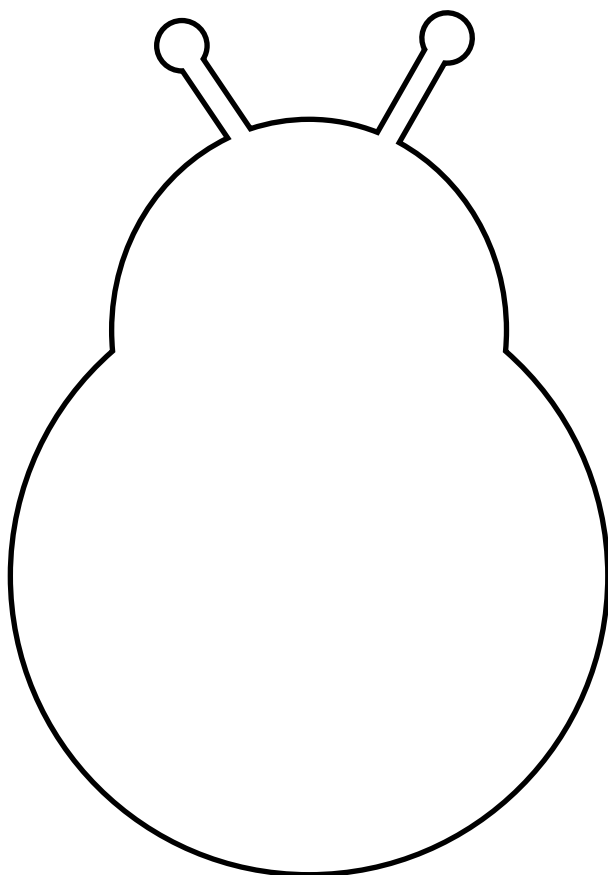

MARIENKÄFER, S. 18

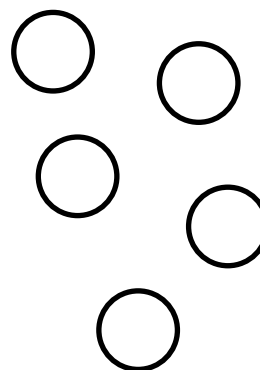
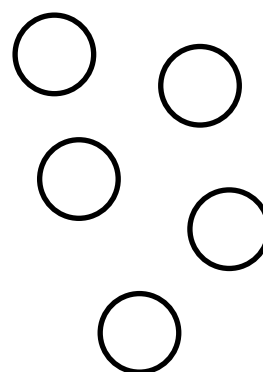

MEIN **NEON** BASTELBUCH

Alle Rechte dieser Ausgabe bei © Edition Michael Fischer GmbH, Igling
www.emf-verlag.de
ISBN 978-3-7459-2335-3

BAUM, S. 20

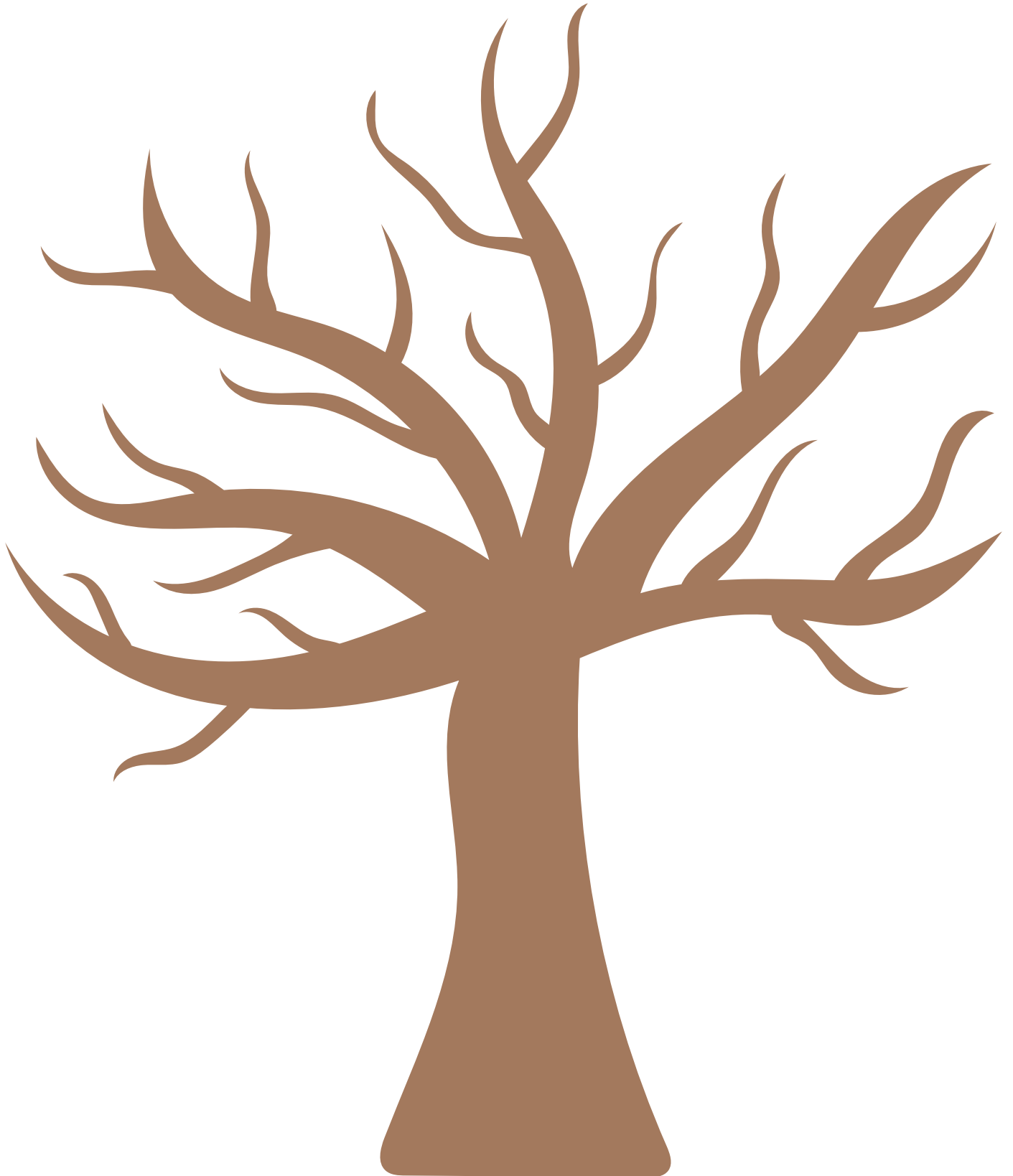

MEIN **NEON** BASTELBUCH

Alle Rechte dieser Ausgabe bei © Edition Michael Fischer GmbH, Igling
www.emf-verlag.de
ISBN 978-3-7459-2335-3

SCHMETTERLING, S. 22

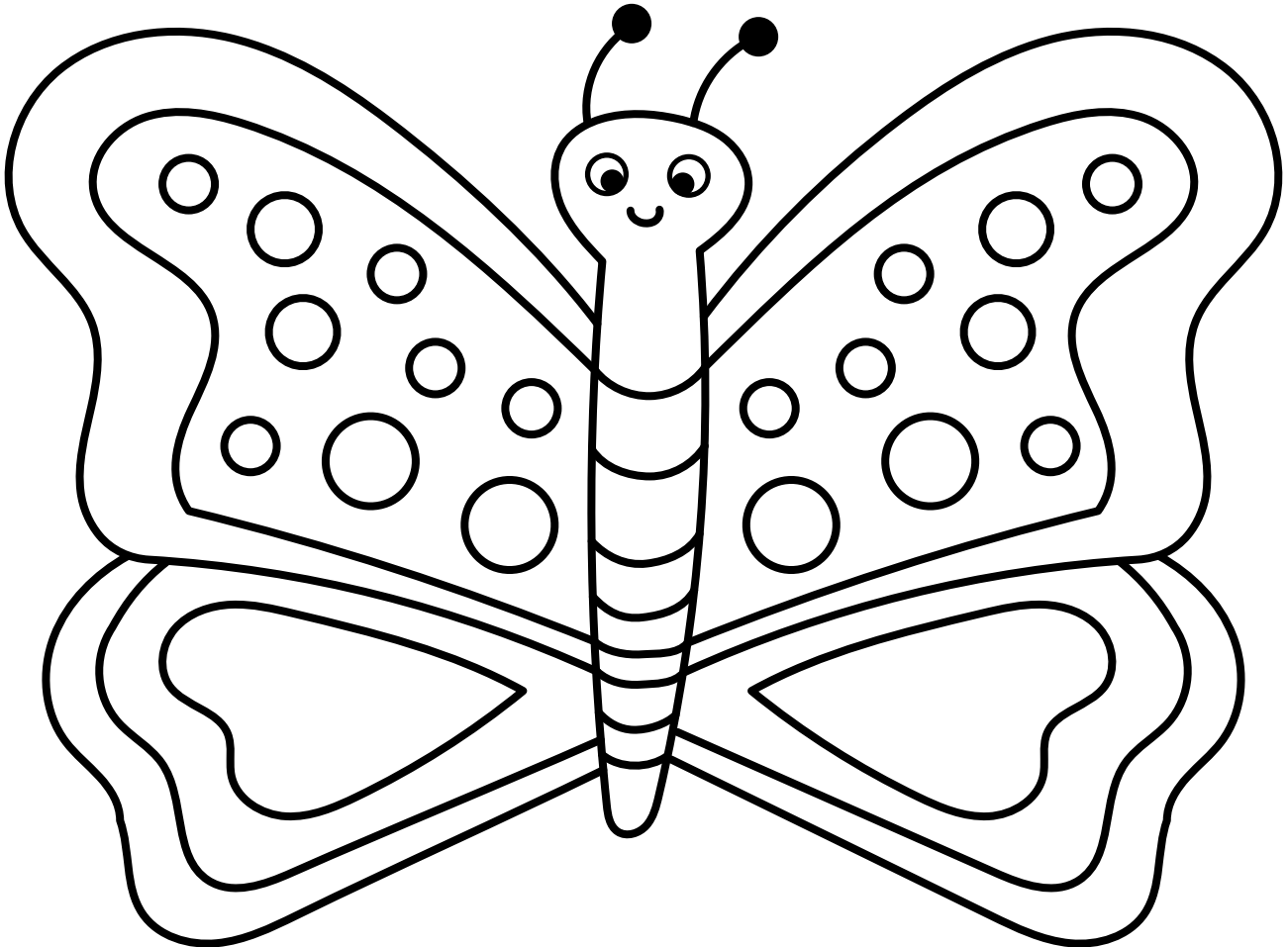

MEIN **NEON** BASTELBUCH

Alle Rechte dieser Ausgabe bei © Edition Michael Fischer GmbH, Igling
www.emf-verlag.de
ISBN 978-3-7459-2335-3



VOGEL, S. 24

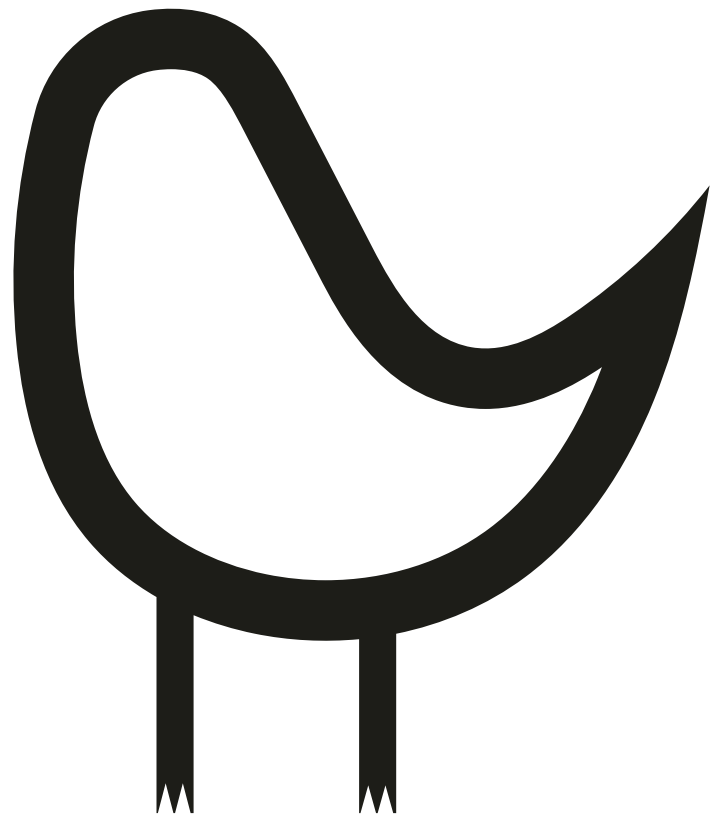
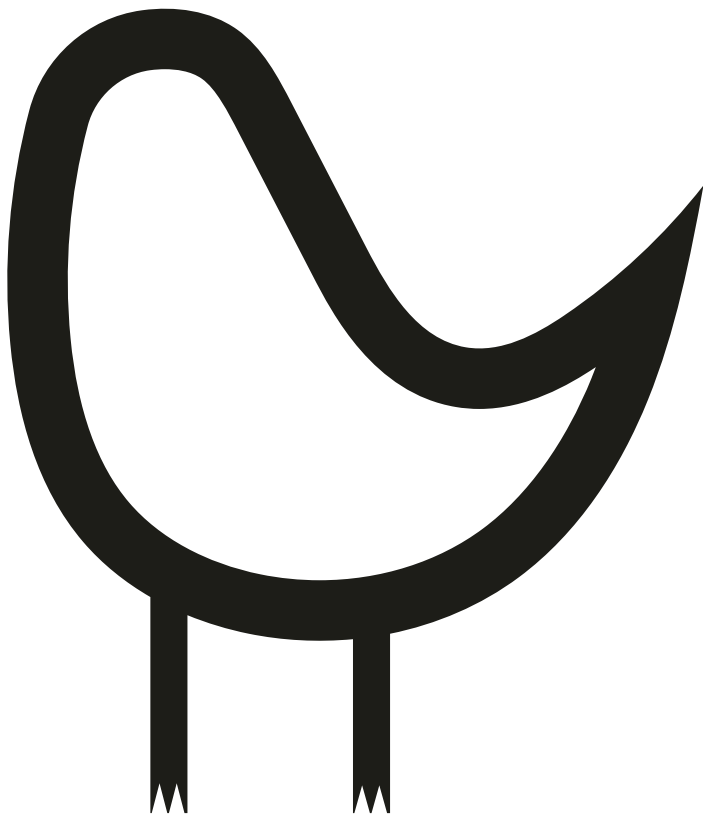
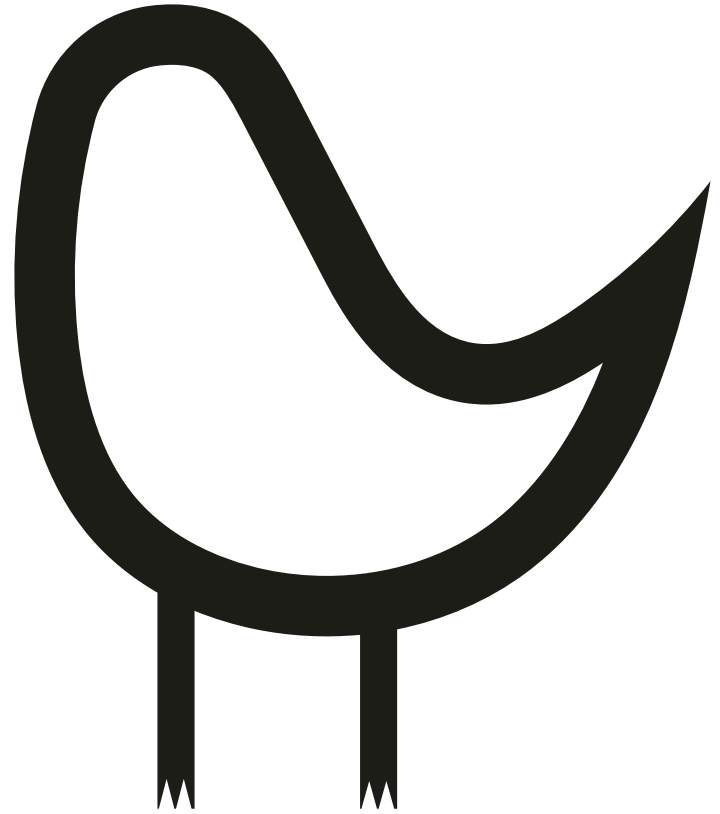
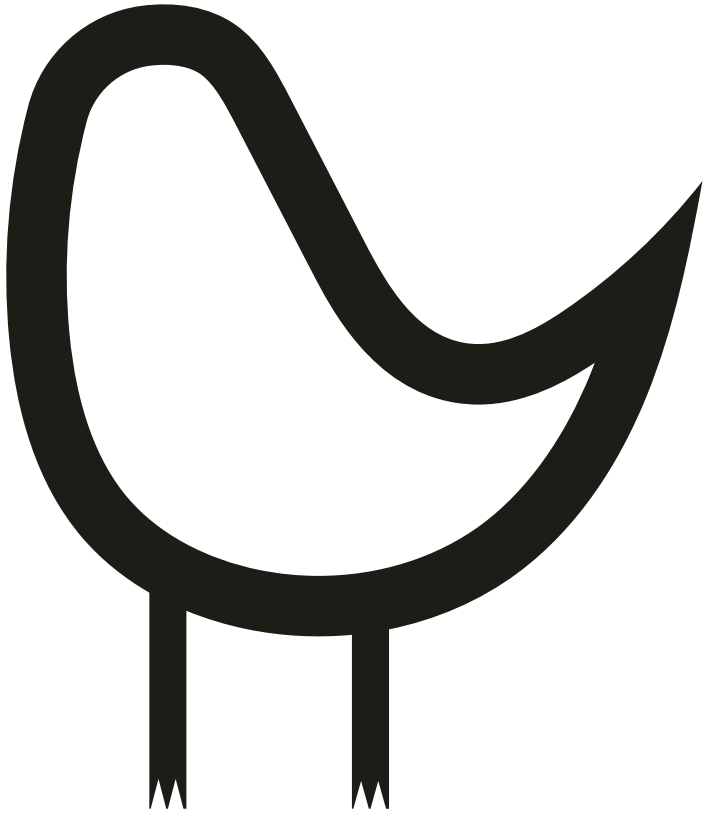

MEIN **NEON** BASTELBUCH

Alle Rechte dieser Ausgabe bei © Edition Michael Fischer GmbH, Igling
www.emf-verlag.de
ISBN 978-3-7459-2335-3



LOLLIHALTER, S. 28

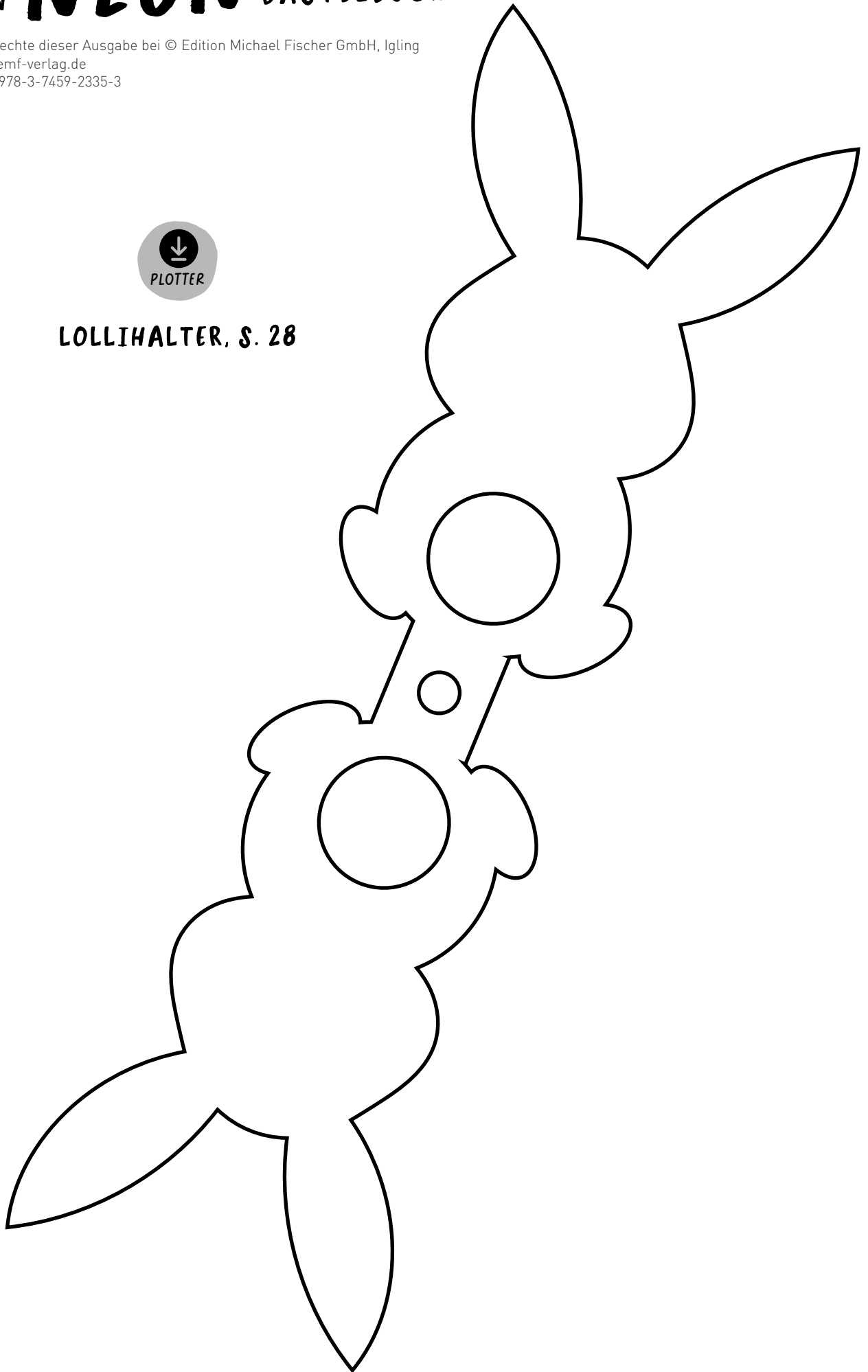

MEIN **NEON** BASTELBUCH

Alle Rechte dieser Ausgabe bei © Edition Michael Fischer GmbH, Igling
www.emf-verlag.de
ISBN 978-3-7459-2335-3



HASE, S. 30

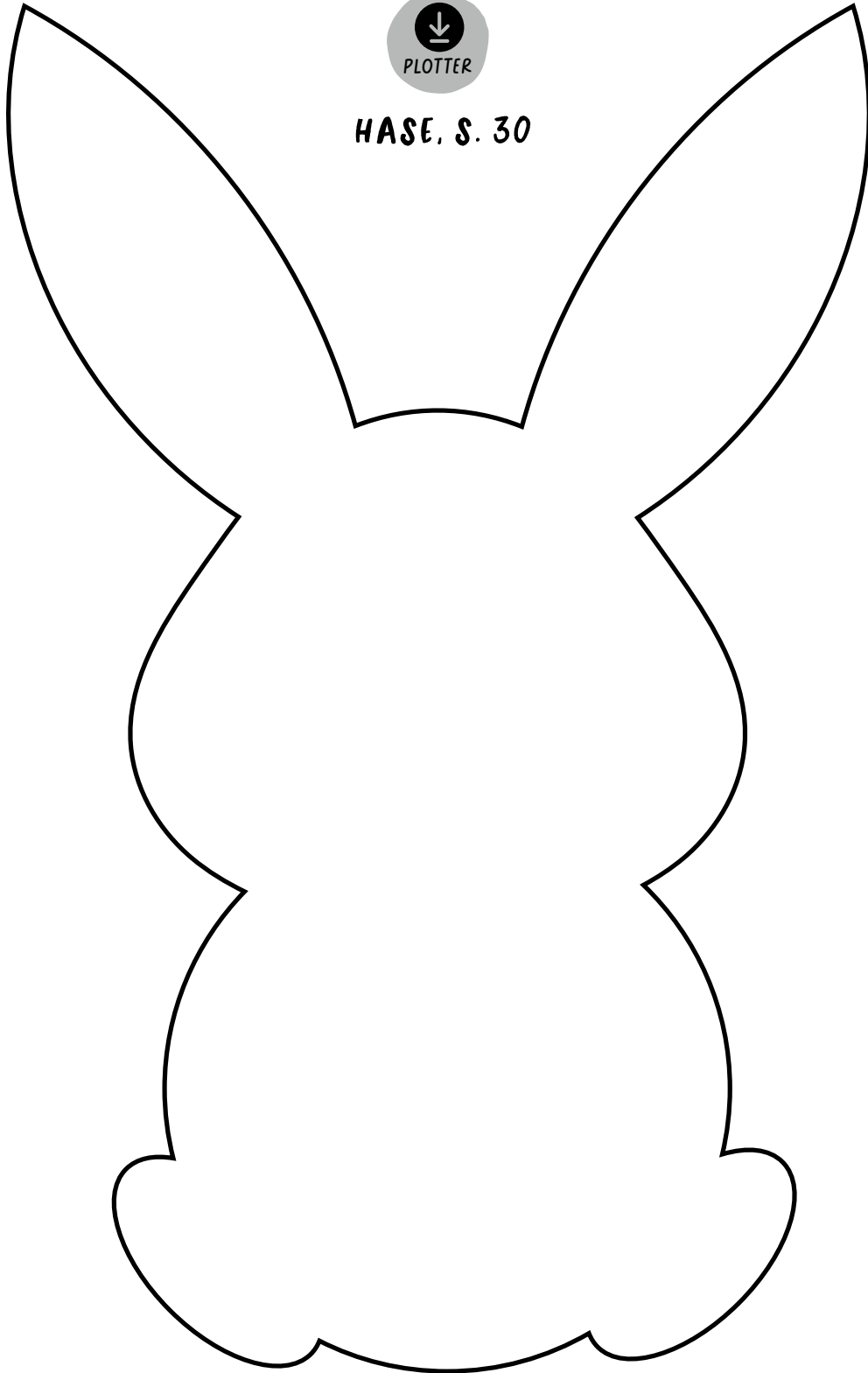

MEIN **NEON** BASTELBUCH

Alle Rechte dieser Ausgabe bei © Edition Michael Fischer GmbH, Igling
www.emf-verlag.de
ISBN 978-3-7459-2335-3

KREPP-SCHMETTERLING, S. 48

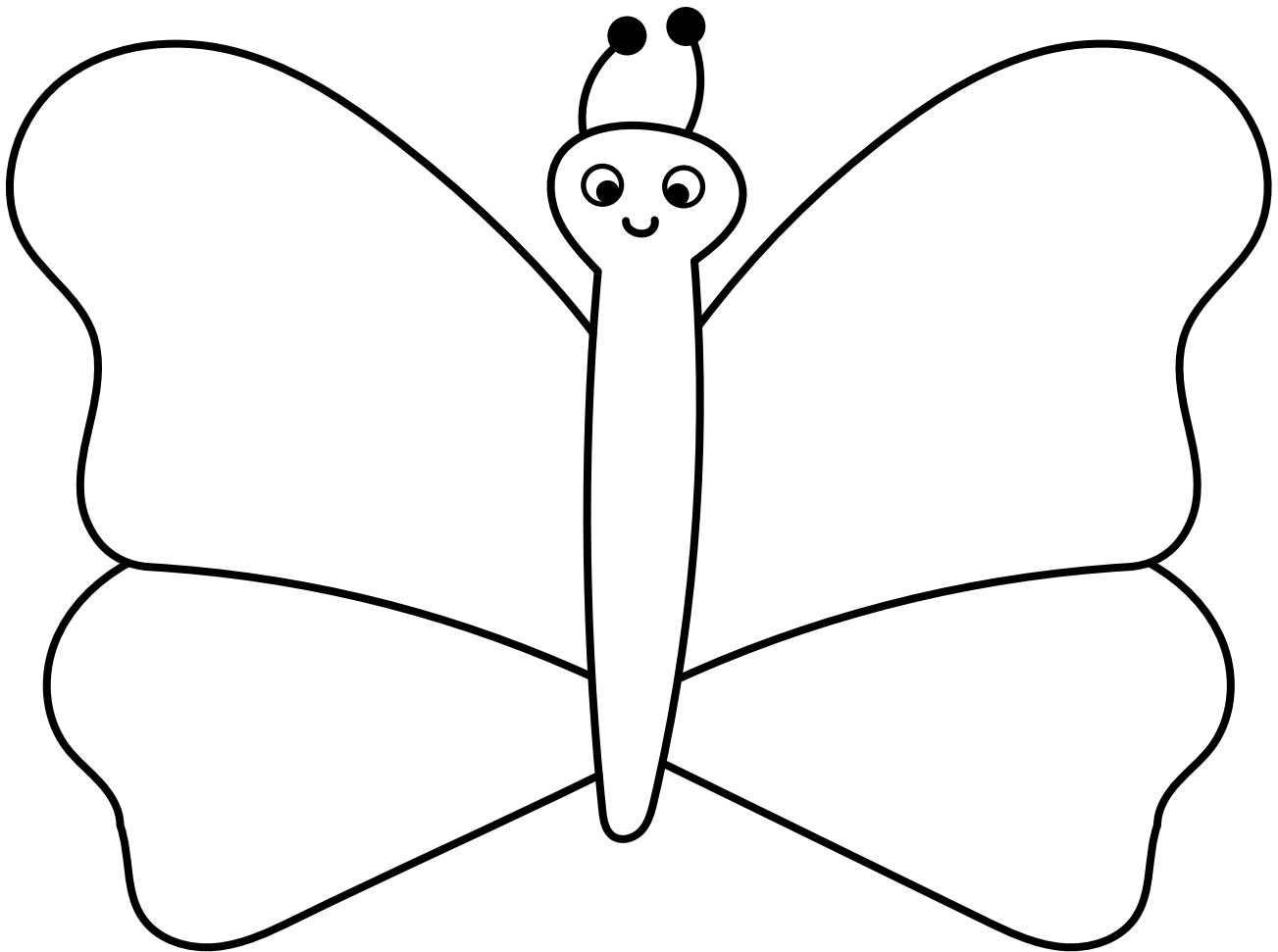

MEIN **NEON** BASTELBUCH

Alle Rechte dieser Ausgabe bei © Edition Michael Fischer GmbH, Igling
www.emf-verlag.de
ISBN 978-3-7459-2335-3

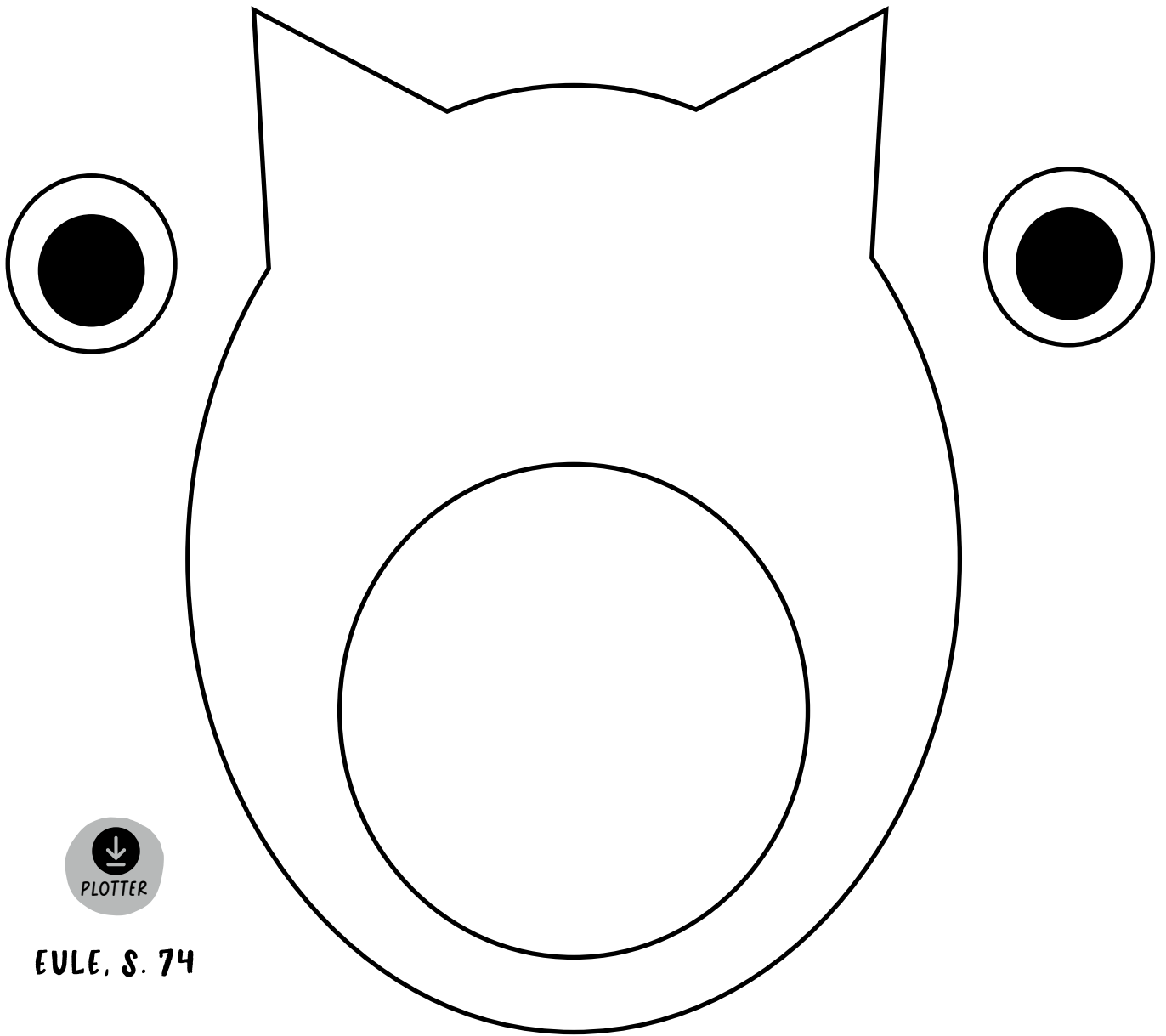

EULE, S. 74

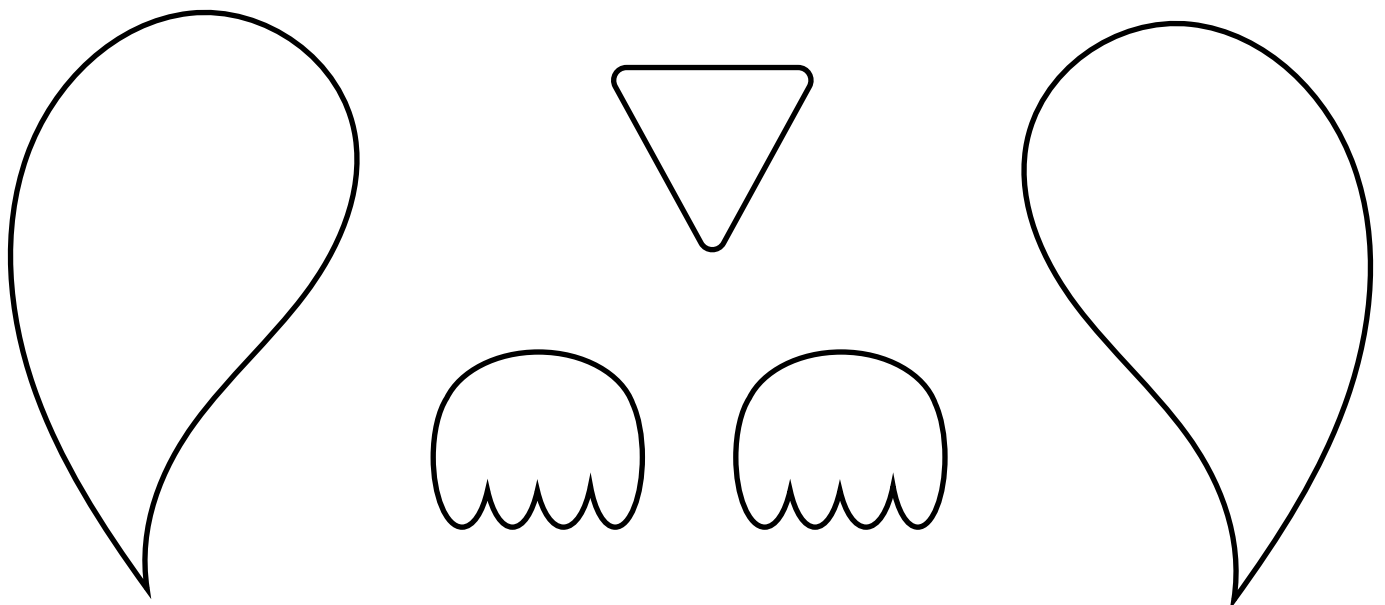

MEIN **NEON** BASTELBUCH

Alle Rechte dieser Ausgabe bei © Edition Michael Fischer GmbH, Igling
www.emf-verlag.de
ISBN 978-3-7459-2335-3

GEISTER, S. 81

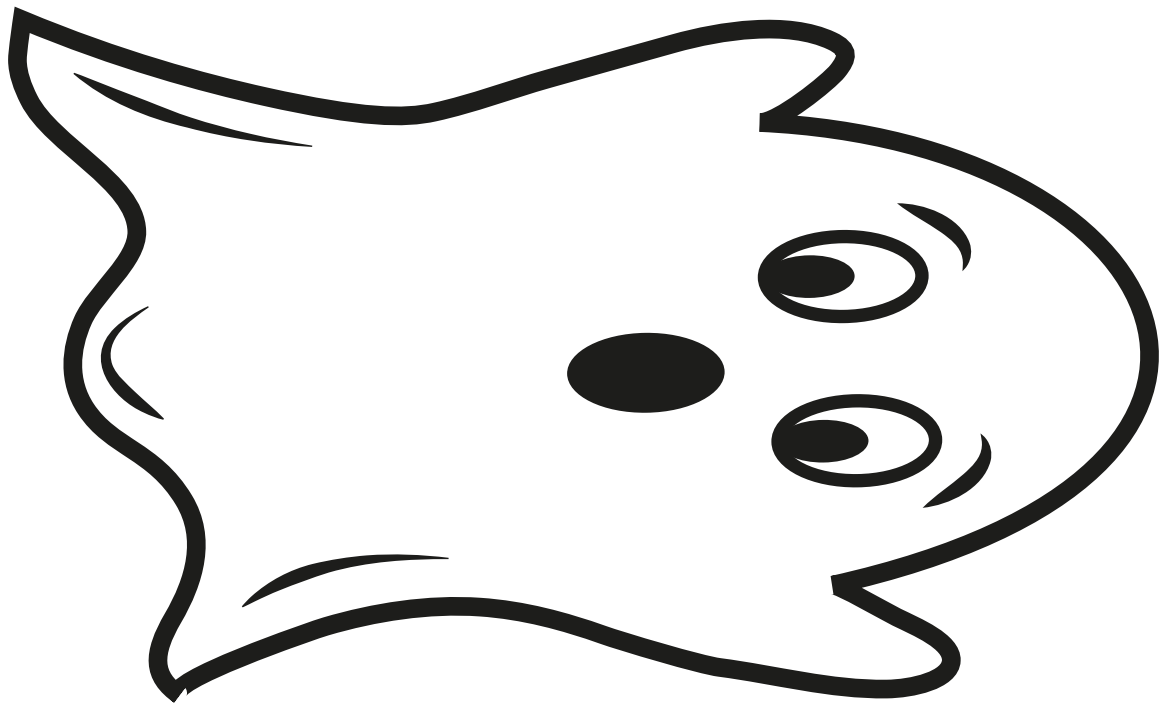

MEIN **NEON** BASTELBUCH

Alle Rechte dieser Ausgabe bei © Edition Michael Fischer GmbH, Igling
www.emf-verlag.de
ISBN 978-3-7459-2335-3

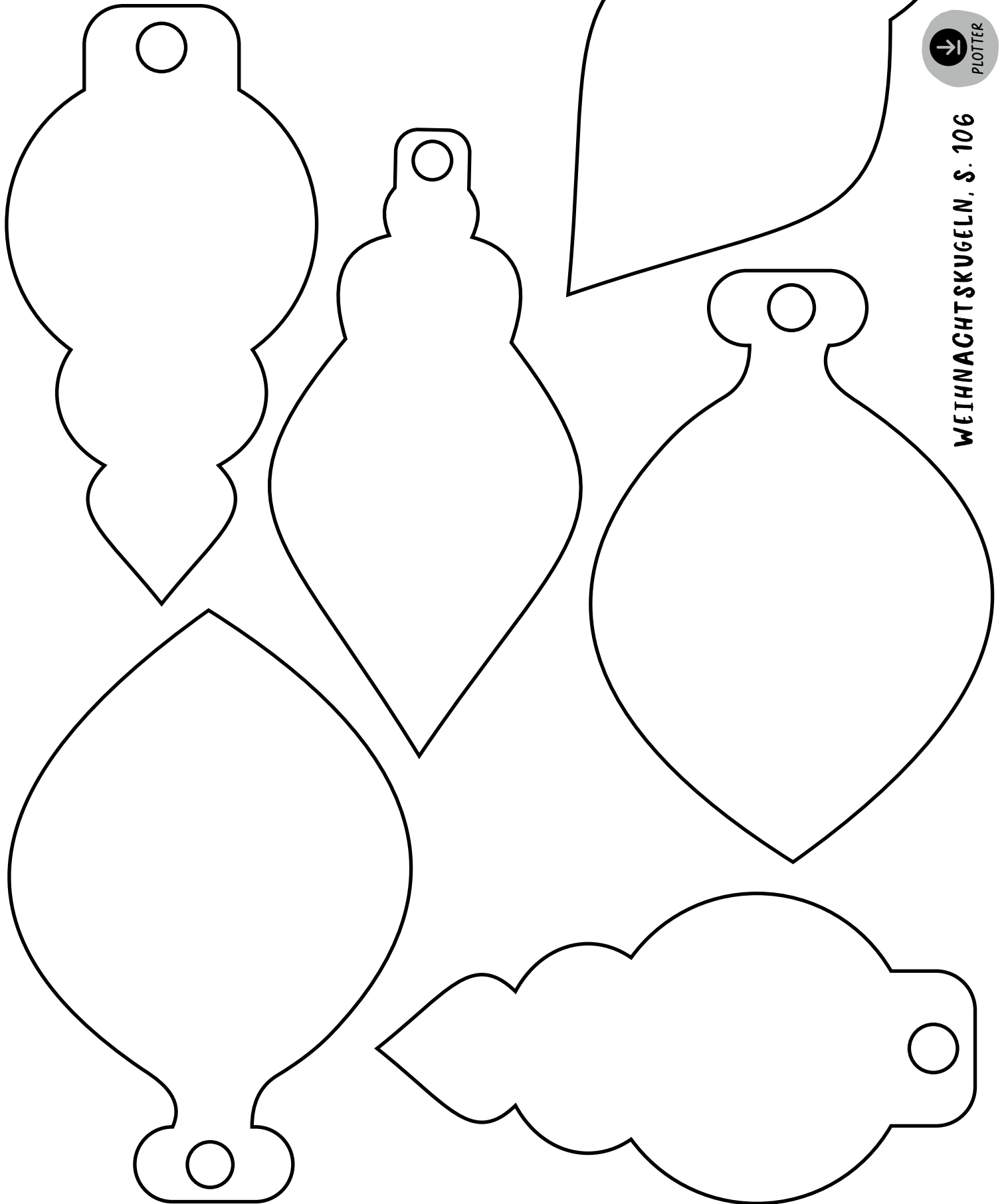

WEIHNACHTSKUGELN, S. 106

MEIN **NEON** BASTELBUCH

Alle Rechte dieser Ausgabe bei © Edition Michael Fischer GmbH, Igling
www.emf-verlag.de
ISBN 978-3-7459-2335-3

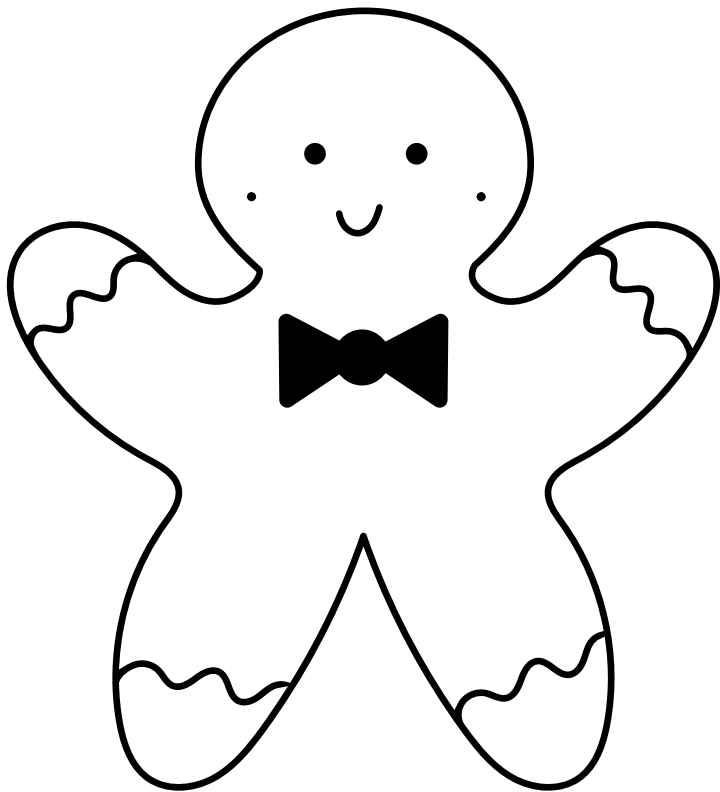

MEIN **NEON** BASTELBUCH

Alle Rechte dieser Ausgabe bei © Edition Michael Fischer GmbH, Igling
www.emf-verlag.de
ISBN 978-3-7459-2335-3

WICHTEL, S. 110



MEIN **NEON** BASTELBUCH

Alle Rechte dieser Ausgabe bei © Edition Michael Fischer GmbH, Igling
www.emf-verlag.de
ISBN 978-3-7459-2335-3



SCHWEINGHEN, S. 112

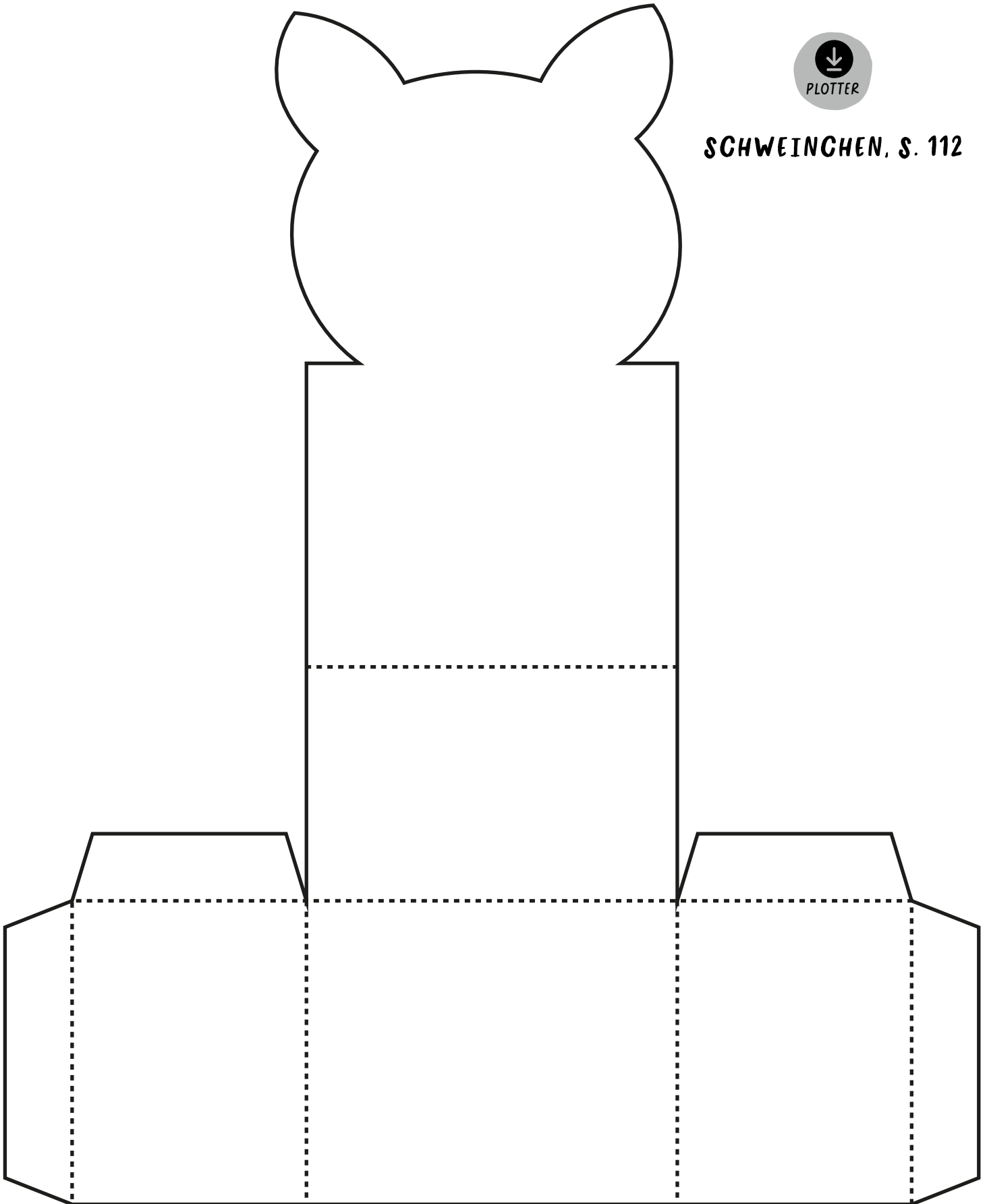

MEIN **NEON** BASTELBUCH

Alle Rechte dieser Ausgabe bei © Edition Michael Fischer GmbH, Igling
www.emf-verlag.de
ISBN 978-3-7459-2335-3

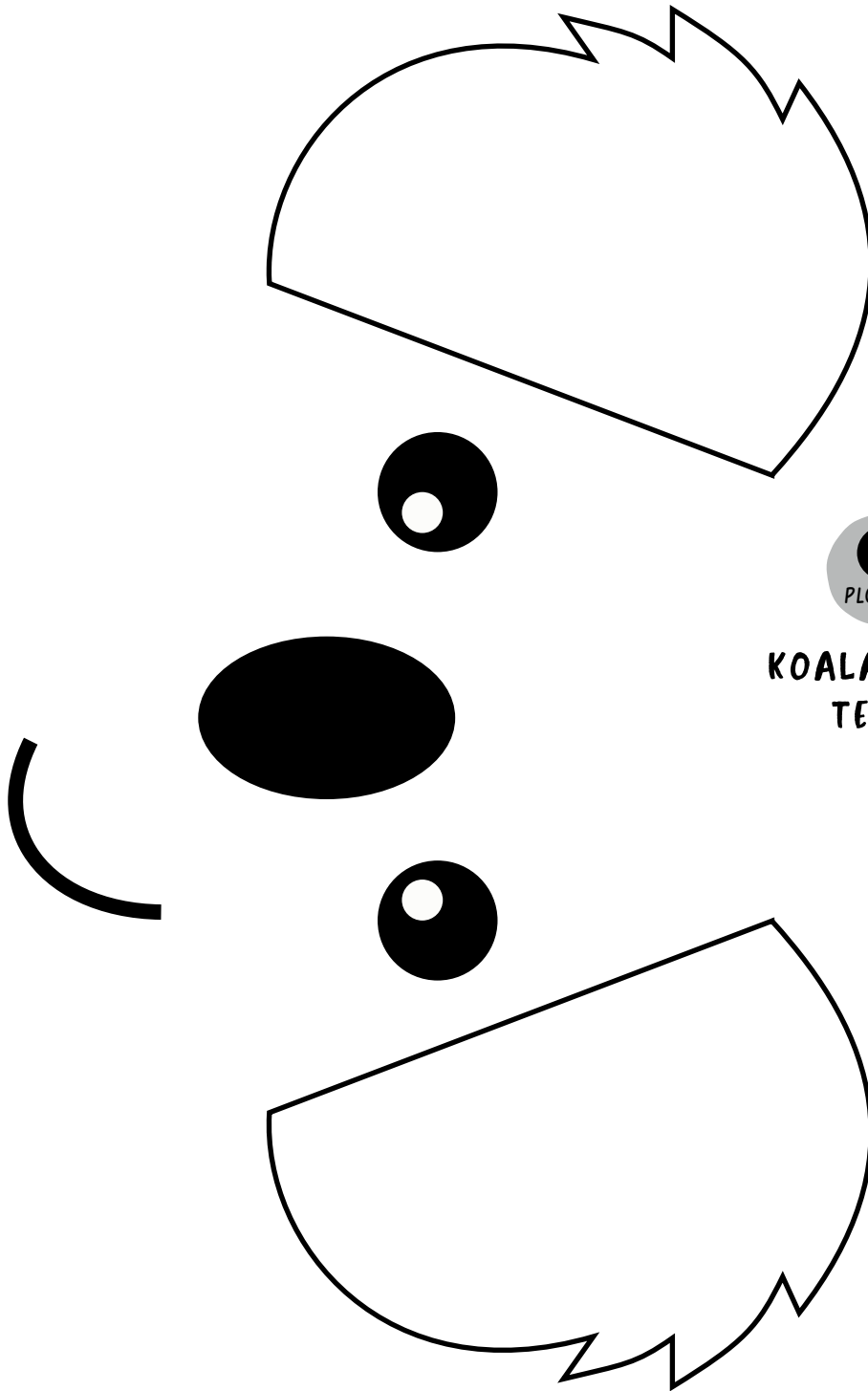

KOALA, S. 116
TEIL 1

MEIN **NEON** BASTELBUCH

Alle Rechte dieser Ausgabe bei © Edition Michael Fischer GmbH, Igling
www.emf-verlag.de
ISBN 978-3-7459-2335-3



KOALA, S. 116
TEIL 2

